



Control box, control and distribution panels

Series 8146/5



Contents

1	General Information	3
1.1	Manufacturer	3
1.2	Information regarding the operating instructions	3
1.3	Further documents	3
1.4	Conformity with standards and regulations	3
2	Explanation of the symbols	3
2.1	Symbols in these operating instructions	3
2.2	Warning notes	4
2.3	Symbols on the device	4
3	Safety notes	5
3.1	Operating instructions storage	5
3.2	Safe use	5
3.3	Modifications and alterations	5
4	Function and device design	5
4.1	Function	5
5	Technical data	6
6	Transport and storage	7
7	Mounting and installation	7
7.1	Dimensions / fastening dimensions	7
7.2	Mounting / dismounting, operating position	8
7.3	Installation	10
8	Commissioning	14
9	Operation	14
10	Maintenance and repair	14
10.1	Maintenance	15
10.2	Maintenance	15
10.3	Repair	15
10.4	Returning the device	16
11	Cleaning	16
12	Disposal	16
13	Accessories and Spare parts	16

1 General Information

1.1 Manufacturer

R. STAHL Schaltgeräte GmbH
Am Bahnhof 30
74638 Waldenburg
Germany

Phone: +49 7942 943-0
Fax: +49 7942 943-4333
Internet: www.stahl-ex.com
E-Mail: info@stahl.de

1.2 Information regarding the operating instructions

ID-No.: 137193 / 8146620300
Publication Code: 2016-02-15-BA00-III-en-09
Hardware version: n/a
Software version: n/a

The original instructions are the English edition.
They are legally binding in all legal affairs.

1.3 Further documents





- Data sheet
- For further languages, see www.stahl-ex.com.

1.4 Conformity with standards and regulations

See certificates and EC Declaration of Conformity: www.stahl-ex.com.

2 Explanation of the symbols



2.1 Symbols in these operating instructions

Symbol	Meaning
	Tips and recommendations on the use of the device
	General danger
	Danger due to explosive atmosphere
	Danger due to energised parts





2.2 Warning notes

Warning notes must be observed under all circumstances, in order to minimize the risk due to construction and operation. The warning notes have the following structure:

- Signalling word: DANGER, WARNING, CAUTION, NOTICE
- Type and source of danger/damage
- Consequences of danger
- Taking countermeasures to avoid the danger/damage

	DANGER
	Danger to persons Non-compliance with the instruction results in severe or fatal injuries to persons.
	WARNING
	Danger to persons Non-compliance with the instruction can result in severe or fatal injuries to persons.
	CAUTION
	Danger to persons Non-compliance with the instruction can result in light injuries to persons.
NOTE	
Avoiding material damage Non-compliance with the instruction can result in material damage to the device and / or its environment.	

2.3 Symbols on the device

Symbol	Meaning
 <small>05594E00</small>	CE marking according to the current applicable directive.
 <small>02198E00</small>	According to marking, device approved for hazardous areas.
 <small>15649E00</small>	Input
 <small>15648E00</small>	Output

3 Safety notes

3.1 Operating instructions storage

- Read the operating instructions carefully and store them at the mounting location of the device.
- Observe applicable documents and operating instructions of the devices to be connected.

3.2 Safe use

- Read and observe the safety notes in these operating instructions!
- Use the device in accordance with its intended and approved purpose only.
- We cannot be held liable for damage caused by incorrect or unauthorized use or by non-compliance with these operating instructions.
- Before installation and commissioning, make sure that the device is not damaged.
- Work on the device (installation, maintenance, overhaul, repair) may only be carried out by appropriately authorized and trained personnel.
- During installation and operation observe the information (characteristic values and rated operating conditions) on the rating, data and information plates located on the device.
- Always consult with R. STAHL Schaltgeräte GmbH in case of operating conditions which deviate from the technical data.

3.3 Modifications and alterations

	DANGER
	<p>Explosion hazard due to modifications and alterations to the device! Non-compliance results in severe or fatal injuries.</p> <ul style="list-style-type: none"> • Do not modify or alter the device. No liability or warranty for damage resulting from modifications and alterations.

4 Function and device design

	DANGER
	<p>Explosion hazard due to improper use! Non-compliance results in severe or fatal injuries.</p> <ul style="list-style-type: none"> • Use the device only according to the operating conditions described in these operating instructions.

4.1 Function

The control and distribution boxes as well as the switching and distribution panels 8146/5 are used together with the built-in devices to control, switch and transfer electric energy.

5 Technical data

Explosion Protection

Global (IECEX)

Gas and dust	IECEX PTB 06.0090 Ex d e ia ib [ia Ga] mb q IIA, IIB, IIC T6, T5, T4 Gb Ex tb IIIA, IIIB, IIIC T80 °C, T95 °C, T130 °C Db
--------------	---

Europe (ATEX)

Gas and dust	PTB 01 ATEX 1024 ⊕ II 2 G Ex d e ia ib [ia Ga] mb q IIA, IIB, IIC T6, T5, T4 Gb ⊕ II 2 D Ex tb IIIA, IIIB, IIIC T80 °C, T95 °C, T130 °C Db IP66
--------------	---

Certifications and certificates

Certificates	IECEX, ATEX, Brazil (INMETRO), China (China-Ex), Canada (CSA, FM, UL), Kazakhstan (TR), Korea (KCs), Russia (TR), Serbia (SRPS), Taiwan (ITRI), Ukraine (TR), USA (FM, UL), Belarus (TR)
--------------	--

Technical Data

Electrical data

Rated voltage	max. 1100 V AC / DC
Rated operational current	max. 630 A
Rated cross-section	max. 240 mm ²

Ambient conditions

Ambient temperature	-60 ... +100 °C (depending on the Ex components used)
---------------------	---

Mechanical data

Degree of protection	IP66
Material	
Enclosure	Polyester resin, glass-fibre-reinforced, dark grey, similar to RAL 7024 Impact resistance ≥ 7 J Surface resistance $\leq 10^9 \Omega$ Flame-resistant according to IEC/EN 60695, UL 94, ASTM D635
Seal	Standard: foamed silicone Special: PU, foamed (-20 ... +80 °C)
Tightening torque	
Terminals	according to specifications of the terminal manufacturer
Cover lock	
Standard	with captive M6 stainless steel combo head screws
Option	with cover hinges

For further technical data, see www.stahl-ex.com.

i	The exact technical data depend on the Ex components used.
----------	--

6 Transport and storage

- Transport and store the device only in the original packaging.
- Store the device in a dry place (no condensation) and vibration-free.
- Do not drop the device.

7 Mounting and installation

7.1 Dimensions / fastening dimensions

Dimensional drawings (all dimensions in mm [inch] - subject to alterations)

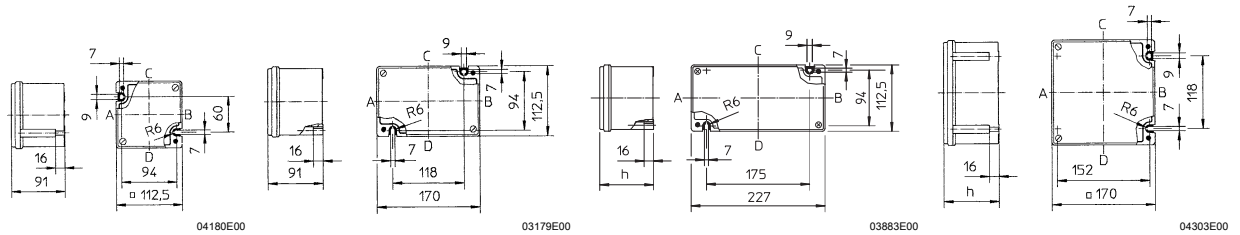

8146/03.

8146/04.

8146/24.

8146/05.

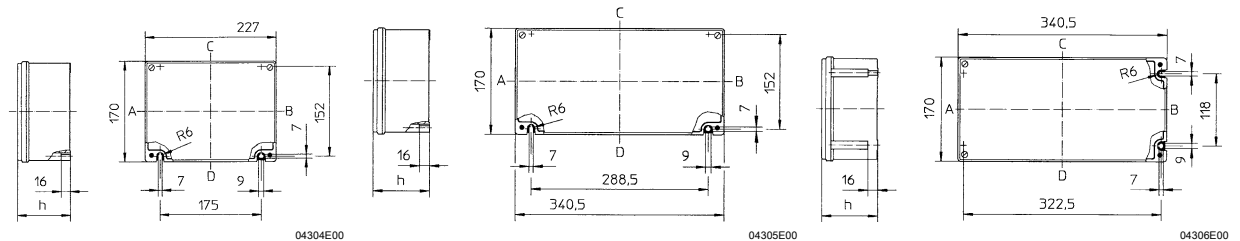

8146/06.

8146/07.

8146/S7.

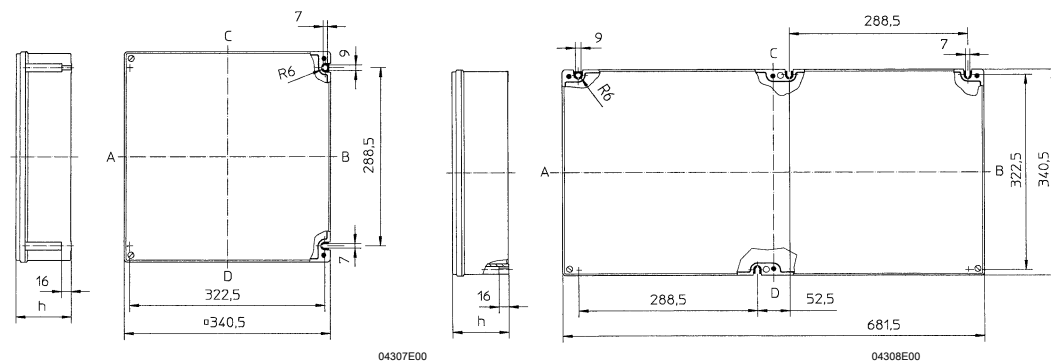

8146/08.

8146/09.

Enclosure height h	Enclosure height h				
	8146/...1 91 mm	8146/...2 131 mm	8146/...3 150 mm	8146/...5 190 mm	8146/...6 230 mm
8146/03.	X	-	-	-	-
8146/04.	X	-	-	-	-
8146/24.	X	X	-	-	-
8146/05.	X	X	-	-	-
8146/06.	X	X	-	-	-
8146/07.	X	X	X	X	-
8146/S7.	X	-	X	-	-
8146/08.	X	X	X	X	X
8146/09.	X	X	X	X	-

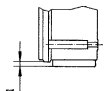

X ... available version



Flange thickness [mm]	Dimension a [mm]
2.8	7
5.8	10

Additional dimension for flange mounting

7.2 Mounting / dismantling, operating position

	DANGER
	<p>Explosion hazard due to incorrect installation of the device! Non-compliance results in severe or fatal injuries.</p> <ul style="list-style-type: none"> • Carry out installation strictly according to the instructions and national safety and accident prevention regulations to maintain the explosion protection. • Select and install the electrical device so that explosion protection is not affected due to external influences, i.e. pressure conditions, chemical, mechanical, thermal and electric impact such as vibration, humidity and corrosion (see IEC/EN 60079-14). • The device must only be installed by trained qualified personnel who is familiar with the relevant standards.
	WARNING
	<p>Risk of heavy device falling down! Non-compliance can result in severe or fatal injuries and material damage.</p> <ul style="list-style-type: none"> • Use suitable lifting tool. • Secure against tilting.

This device is suitable for outdoor and indoor use.

- Provide a protective roof or wall if enclosure and explosion protected electric equipment is used outdoors.
- Information regarding mechanical assembly, such as location of fastening points, dimensions or weight of the switchgear combinations, is given in the enclosed assembly drawing.
- Direct assembly or assembly by means of the frame system 8298 is possible. (The frame system can only be used for the enclosures 8146/.7., 8146/.8. and 8146/.9.)
- Observe the weight of the enclosure according to the type and number of the built-in components.

7.2.1 Opening and closing the enclosure cover

	Rotary actuators installed on the cover may optionally be equipped with a cover lock. In this case, the cover can only be removed or closed in one specific position.
---	---

- Loosen the screws on the enclosure cover.
- If necessary, observe the cover lock at the rotary actuator.
- Carefully open or remove the enclosure cover.
- To close the enclosure cover, proceed in reverse order.
- Observe the specified tightening torque.

Type	Tightening torque [Nm]	Screw type
8146	4.5	Pan-head screws M6 x 28

7.2.2 Making Additional through Holes

If additional through holes are required, for example for fastening cable glands, breathers or other built-in parts in the enclosure, the following has to be observed:

- When determining positions of the through holes, observe the mounting distance to ensure collision-free mounting.
- Space requirements result from the width across corners of the cable gland plus the space required for the tool used to fasten the cable gland.
- Adjust the hole diameters to the dimensions of the built-in parts and/or their seals.
- Measure the dimensions on the plane surfaces of the inner side of the enclosure, not on the outer side of the enclosure.
- Make sure that the through holes are located on the plane surfaces of the enclosure sides with parallel running interior and exterior contours.
- Additional through holes can be bored, laser-cut or punched.
- During punching make sure that the surfaces remain flat.
- Do not damage circumferential sealing lips.

7.2.3 Transport protection for holes

	DANGER
	<p>Explosion hazard due to leaking holes! Non-compliance results in severe or fatal injuries.</p> <ul style="list-style-type: none"> • Open holes protected with an adhesive tape must be sealed by means of adapted and certified components. • Remove the adhesive tape completely. • Make sure that the components comply with the IP-protection.

7.2.4 Operating position

	<ul style="list-style-type: none"> • Alignment of enclosure depending on mounting type: • For vertical mounting: any alignment • For horizontal mounting: cover on top • Hanging position/overhanging cover is not permitted!
--	---

7.3 Installation

	<p style="text-align: center;">DANGER</p> <p>Explosion hazard due to impermissible cable glands! Non-compliance results in severe or fatal injuries.</p> <ul style="list-style-type: none"> • Use only cable glands approved for the required type of protection. • When selecting cable glands, observe the thread type and thread size in the equipment documentation. • Make sure that the conductor diameter matches the clamping cross-section of the cable glands.
	<p style="text-align: center;">DANGER</p> <p>Explosion hazard due to incorrectly laid cables in the Ex e enclosure! Non-compliance results in severe or fatal injuries.</p> <ul style="list-style-type: none"> • Adhere to the required creepage distances and clearances. • Fasten mounting rails or elements properly.
	<p style="text-align: center;">DANGER</p> <p>Explosion hazard due to cable glands without strain relief! Non-compliance results in severe or fatal injuries.</p> <ul style="list-style-type: none"> • Lead cables and conductors securely. • If the cables are laid loosely, use only cable entries approved for this type of cable laying.
	<p style="text-align: center;">WARNING</p> <p>Danger of electric shock due to energised parts! Non-compliance can result in severe or fatal injuries.</p> <ul style="list-style-type: none"> • All connections and wiring must be disconnected from the power supply. • Secure the connections against unauthorized switching.
	<p>If core end sleeves are used, they must be fitted with a suitable tool.</p>

7.3.1 Electrical Connection

- The information given in chapter "Technical Data" must be observed.
- The conductor must be connected carefully.
- The conductor insulation must reach to the clamping units.
- Do not damage the conductor (nicking) when stripping it.
- Ensure that the maximum permissible conductor temperatures and the maximum permissible surface temperature are not exceeded by selecting suitable electric lines and means of running them.
- Avoid mechanical damage to the conductor insulation due to rubbing against sharp-edged metal parts.

Connection to the mains

- Open the enclosure (see chapter "Mounting/dismounting, operating position").
- Guide the connection lines into the connection chamber using the cable glands.
- Lay the connecting wires in the terminal compartment in such a way that the permissible bending radii do not drop below the minimum.
- Connect the conductors according to the enclosed documents (e.g. wiring diagrams).
- Connect the protective conductor.
- If necessary, remove loose metal particles, dirt and traces of moisture from the enclosure.
- Carefully close the enclosure after completing the work.

7.3.2 Back-up fuse

- Secure the system by means of the specified electric back-up fuse.
- Ensure sufficient short-circuit current in the system.

7.3.3 Internal wiring

WARNING	
	<p>Risk of electric shock (short circuit) due to incorrectly dimensioned cables and conductors!</p> <p>Non-compliance can result in severe or fatal injuries.</p> <ul style="list-style-type: none"> • Run wires and cables with a minimum distance of 8 mm to wires and cables of other intrinsically safe circuits. • An isolating plate must be mounted between the connection points of intrinsically safe and non-intrinsically safe circuits at a distance of up to 1.5 mm from the enclosure wall. • A minimum distance or tight string length of 50 mm around an insulating or earthed metal isolating plate must be provided between the connection points of intrinsically-safe and non-intrinsically safe circuits. • Use only insulated cables and conductors with a testing voltage of at least 500 V AC and a minimum quality of H05. • Make sure that the diameter of individual conductors/wires and individual finely stranded conductors must not be smaller than 0.1 mm.

Insulation test voltage

As regards the insulation and separation of terminals and conductors, note that the insulation test voltage is derived from the sum of the rated operational voltages of intrinsically-safe circuits.

"Intrinsically safe against earth"

In case of "intrinsically safe to earth", there is a minimum insulation voltage value of 500 V (otherwise, double value of the rated operational voltage of intrinsically safe circuits).

"Intrinsically safe against non-intrinsically safe"

In case of "intrinsically safe against non-intrinsically safe" the insulation voltage value is at least 1500 V (doubled sum of the rated operational voltage of intrinsically-safe circuits plus 1000 V).

i	The conductors of intrinsically safe or non-intrinsically safe circuits are protected by an earthed shield.
----------	---

Terminal blocks in Ex e enclosure

i	<p>Observe the following when working on terminal blocks:</p> <ul style="list-style-type: none"> • Observe the test certificate of the terminals. • Terminal bridging is only permitted if original Ex accessories are used. • If necessary, retrofit required partitions. • For additional splice protection, use core end sleeves or cable lugs. • Make sure that the cross section of the splice protection matches the conductor cross section.
----------	--

7.3.4 External wiring

Protective conductor

- Always connect the protective conductor.
- Regardless of the operating voltage, connect all uncoated and non-energised metal parts to the protective conductor system.
- The neutral conductor is considered as a live conductor and it has to be installed accordingly.
- Inactive metal parts are insulated in accordance with IEC/EN 61439 and not connected to PE.

i	Information regarding the equipotential bonding (PA), earthing (PE) and intrinsically-safe circuits is given in the documentation of the installed devices
----------	--

Protective conductor for cable cross-section up to 10 mm²

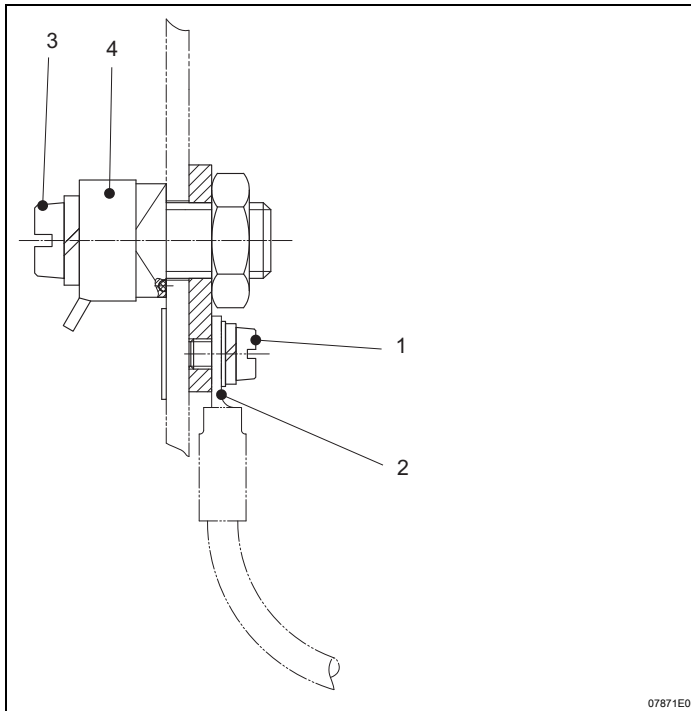

- Unscrew the pan-head screw (1).
- Fasten the PE cable lug (2) using the pan-head screw (1).
- Loosen the pan-head screw (3).
- Slide the conductor under the clamping plate (4).
- Tighten the pan-head screw (3).
- Tighten the pan-head screw (3) to a torque of 4.5 Nm.
- Tighten the nut M10 to a torque of 23 Nm.

Protective conductor for cable cross-section up to 16 mm²

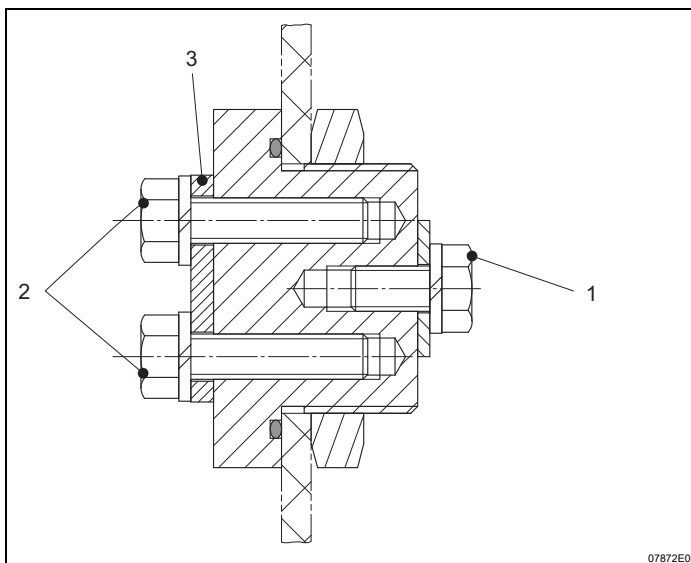

- Connect the outer PE connection line located under the clamping plate (3) to the hexagon screws (2).
- Connect the inner PE connection line to the hexagon screws (1) using a cable lug.
- Tighten the hexagon screw (1 and 2) to a tightening torque of 4.7 Nm.
- Tighten the nut M33 to a torque of 20 Nm.

After completing the electric installation, the following operations must be performed:

- Install protection against accidental contact.
- Set the tripping devices to the nominal value.
- Visual inspection for signs of loose metal particles, soiling and traces of moisture.
- Clean and dry the enclosures, if necessary.



Also observe the enclosed documents such as wiring diagrams and similar documents.

8 Commissioning

	DANGER
	<p>Explosion hazard due to incorrect installation! Non-compliance results in severe or fatal injuries.</p> <ul style="list-style-type: none"> • Check the device for proper installation and function before commissioning. • Comply with the national regulations.

Before commissioning, ensure the following:

- Check the mounting and installation.
- Inspect enclosure for damage.
- If necessary, remove foreign bodies.
- If necessary, clean the connection chamber.
- Check whether the cables have been inserted correctly.
- Check if all screws and nuts have been tightened firmly.
- Check whether all the cable entries and stopping plugs have been tightened firmly.
- Check whether all conductors have been clamped firmly.
- Check whether all covers and partitions for live parts have been installed and fastened.
- Seal unused cable entries using plugs with a respective certification and unused holes with stopping plugs certified for the respective type of protection.
- Check the tightening torques.

NOTE

Also observe the further documentation such as the device list, wiring diagram etc.

9 Operation

The control and distribution devices 8146/5 are installed in customer-specific installations. The requirements during operation therefore depend to a large extent on the operating conditions and the installation on site.

	<p>In order to ensure a correct operation, observe the documentation and the instructions of the operating company!</p>
---	---

10 Maintenance and repair

	WARNING
	<p>Risk of electric shock or malfunctioning of the device due to unauthorized work! Non-compliance can result in severe injuries and material damage.</p> <ul style="list-style-type: none"> • Work performed on the device must only be carried out by appropriately authorized and qualified electricians.



10.1 Maintenance

- Consult the relevant national regulations to determine the type and extent of inspections.
- Adapt inspection intervals to the operating conditions.



During maintenance of the device, check at least:

- whether the clamping screws holding the electric lines are securely seated,
- whether the device enclosure and / or protective enclosure have cracks or other visible signs of damage,
- whether the permissible ambient temperatures are observed,
- whether the device is used according to its designated use.

10.2 Maintenance

	WARNING
	<p>Danger of electric shock due to energised parts! Non-compliance can result in severe or fatal injuries.</p> <ul style="list-style-type: none"> • All connections and wiring must be disconnected from the power supply. • Secure the connections against unauthorized switching.
	<p>Observe the relevant national regulations in the country of use.</p>
	<p>Exception! Devices with intrinsically safe and non-intrinsically safe circuits provided with the note "Non-intrinsically safe circuits protected by internal IP30 cover" can be opened while carrying voltage.</p>

10.3 Repair

	DANGER
	<p>Explosion hazard due to improper repair! Non-compliance results in severe or fatal injuries.</p> <ul style="list-style-type: none"> • Repair work on the devices must be performed only by R.STAHL Schaltgeräte GmbH.
	<p>If the components are damaged, they must be replaced.</p>

10.4 Returning the device

Use the "Service form" to return the device when repair/service is required. On the internet site "www.stahl-ex.com" under "Downloads > Customer service":

- Download the service form and fill it out.
- Send the device along with the service form in the original packaging to R. STAHL Schaltgeräte GmbH.

11 Cleaning

- Clean the device only with a cloth, brush, vacuum cleaner or similar items.
- When cleaning with a damp cloth, use water or mild, non-abrasive, non-scratching cleaning agents.
- Do not use aggressive detergents or solvents.

12 Disposal

- Observe national and local regulations and statutory regulation regarding disposal.
- Separate materials when sending it for recycling.
- Ensure environmentally friendly disposal of all components according to the statutory regulations.

13 Accessories and Spare parts

NOTE	
<p>Malfunction or damage to the device due to the use of non-original components. Non-compliance can result in material damage.</p> <ul style="list-style-type: none"> • Use only original accessories and spare parts from R. STAHL Schaltgeräte GmbH. 	
	<p>For accessories and spare parts, see data sheet on our homepage www.stahl-ex.com.</p>